



RDE100.1RF



RCR100RF

Wireless room thermostat with auto timer

RDE100.1RFS

for heating systems

-
- Room temperature control
 - 2-position / TPI control with On/Off output for heating
 - Optimum Start / Stop
 - Comfort, Economy, Auto Timer and Protection mode
 - Auto Timer
 - Adjustable commissioning and control parameters
 - Battery-powered room thermostat DC 3 V (RDE100.1RF)
 - Mains-powered receiver AC 230 V (RCR100RF)
 - Multifunction input for external floor sensor, keycard contact, etc.

Use

The RDE100.1RFS is used to control the room temperature in heating systems.

Typical applications:

- Apartments
- Commercial spaces
- Schools

For the control of the following pieces of equipment:

- Thermal valves or zone valves
- Gas or oil boilers
- Fans
- Pumps
- Floor heating systems

Functions

- Room temperature control via built-in sensor or external input
- Operating mode switchover contact (keycard, window contact, etc.)
- One multifunctional input freely selectable for floor heating temperature limitation function
- Selection of operating mode via touchkey
- Setting time switches (individual days, 7 days, or days 5-2)
- Display of current room temperature or setpoint in °C or °F
- Touchkey lock (manually)
- Setpoint lock
- Periodic pump run
- Optimum start / stop
- Comfort temperature limitation by Economy setpoint locked
- Reloading factory settings for commissioning and control parameters
- Standalone wireless transmitter and receiver
- Wireless operating frequency 433 MHz

Temperature control

RDE100.. comprises of both 2-position and TPI temperature controls, which can be configured by parameter P78 (Control Behavior).

2-position control algorithm is to switch on and off the heating system within a switching differential according to comparison between setpoint setting and the measured room temperature.

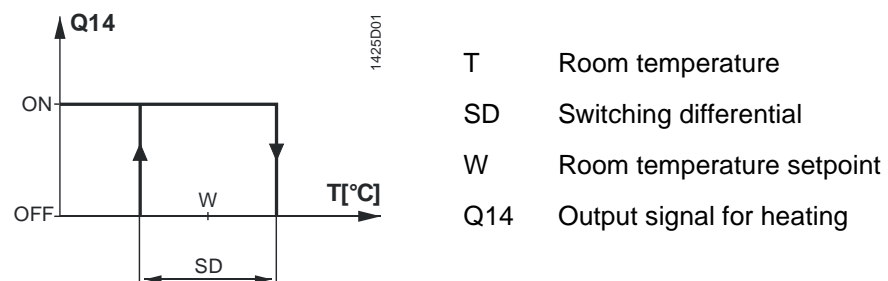

TPI (Time proportional Integral) control algorithm is to periodically switch on and off the heating system. The period time and pulse length of the control signal (PWM) are determined by the setpoint and the measured room temperature.

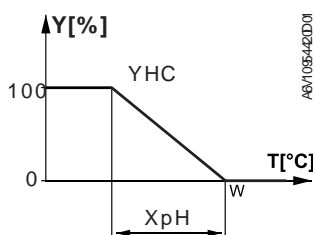

- Heating mode
- T Room temperature
- Y Output signal for heating (PWM)
- W Room temperature setpoint
- YHC Control command "Valve"
- XpH Proportional band "Heating"

Floor heating application

The factory setting for this function is Off (disabled) and must be set to "On" if floor heating is used.

The external floor temperature sensor is connected to input X1, \perp and acquires the floor temperature. If the floor temperature exceeds the parameterized temperature limit xx °C (P14 = 1, P15 = 1, P16 = xx °C), the heating valve is fully closed until the floor temperature returns to a level below the parameterized limit. Typical application is rooms (dry floor).

If the application does not require floor heating temperature limitation but instead uses the external sensor as a source for both room temperature display and control, the parameters will have to be set as follows: P14 = 1, P15 = 0. A typical application is the bathroom (wet floor) where a constant floor temperature is required.

It is not recommended to have **only** an internal built-in room sensor for floor heating since there is a potential risk of overheating.

Typical application: Maximum temperature limitation for under floor heating systems

Operating mode changeover function

This function offers the keycard application (refer to the section "Operating notes", "Economy mode").

Periodic pump or valve kick

This function can only be used when a circulating pump or valve is controlled! It protects the pump or valve against seizing during longer off periods. The pump or valve kick is activated for 3 minutes every 24 hours at 12:00.

Parameter	Pump state
P12 = 0 (default)	Off
P12 = 1	On

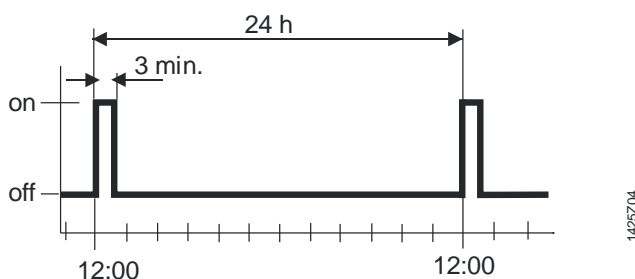

Optimum start control

The purpose of optimum start control is to reach a temperature level 0.25 K below the Comfort setpoint when occupancy according to the time program starts in Auto timer mode. For that purpose, the heating circuit must be switched on at an earlier point in time. The extent of forward shift depends primarily on the outside temperature.

The maximum forward shift on time can be adjusted by parameter P89. A Forward shift on maximum "0" means the function is disabled.

Parameter	Range	Factory setting
Forward shift on max (P89)	0, 0.5,...24 h	0

Optimum stop control

Optimum stop control switches off the heating circuit at the earliest possible point in time so that the room temperature will lay 0.5 K below the Comfort setpoint when the time switch changes from Comfort mode to Economy mode in Auto timer mode. The early shut down maximum time can be adjusted by parameter P90. Early shut down maximum "0" means the function is disabled.

Parameter	Range	Factory setting
Early shutdown max (P90)	0, 0.5,...6 h	0

Control behavior (P78)

The new control algorithm of RDE100.. family offers a choice of control actions that can be configured via parameter **P78**. This means that optimum control can be selected for every type of application (**factory setting "TPI slow"**).

2-position, 1 K

2-Position controller with 1 [K] switching hysteresis

2-position, 0.3 K

- 2-Position controller with 0.3 [K] switching hysteresis.
- For general control situations. Provides a better comfort than 1 [K] switching hysteresis.
- Can also be used for difficult control situations.

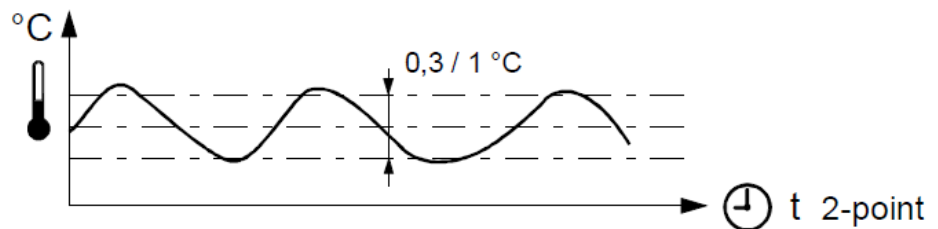

TPI slow

TPI control behavior for slow heating systems that require longer minimum On times and limited numbers of switching cycles per hour.

Typical applications:

- Floor heating systems, oil fired boilers
- Can also be used for all other types of heating applications. (Alternative setting)

Minimum switching on / off time	> 4 minutes
Average period time	Approximately 20 minutes

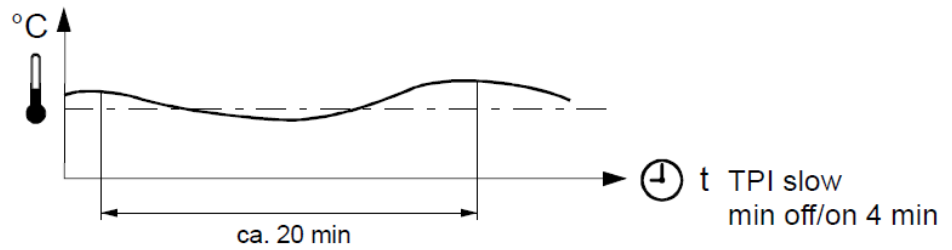

TPI medium

TPI control behavior for general heating applications such as radiator systems, thermal actuators, ...

Minimum switching on / off time	> 1 minute
Average period time	Approximately 20-25 minutes

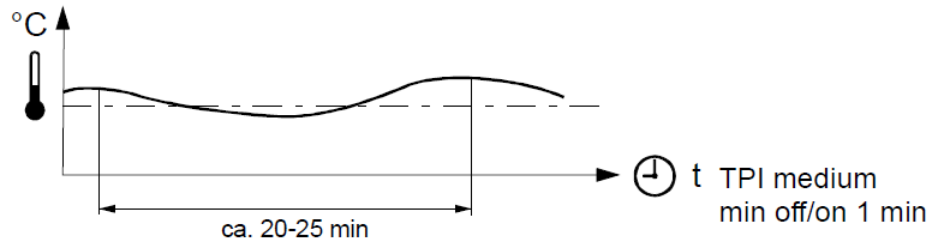

TPI fast

TPI control behavior for fast heating systems that tolerate a high number of switching cycles.

Typical applications: electric heaters, gas boilers, fast thermal actuators

Minimum switching on / off time	> 1 minute
Average period time	Approximately 10 minutes

⚠ Do not use TPI fast for oil boilers or electro mechanical actuators!

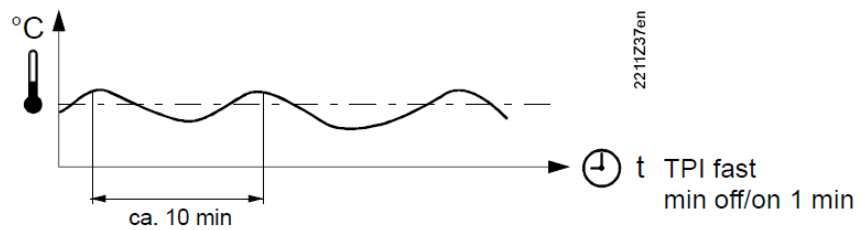

Type summary

Product No.	Stock No.	Features
RDE100.1RF	S55770-T320	Battery-powered room thermostat DC 3 V
RCR100RF	S55770-T418	Receiver AC 230 V









Ordering

When ordering, please indicate product No. / stock No. and description.

Product No.	Stock No.	Description
RDE100.1RFS	S55770-T282	Set consisting of room thermostat and receiver

Valve actuators/external sensor must be ordered separately.

Equipment combinations

Description		Product No.	Data Sheet *)	Use with the type of Temperature Control
Electromotoric actuators		SFA21..	4863	2-Position & TPI slow
Electrothermal actuators (for radiator valves)		STA23..	4884	2-Position & All TPI
Electrothermal actuators (for small valves 2.5 mm)		STP23..	4884	2-Position & All TPI
Damper actuators		GDB..	4634	2-Position & TPI slow
Damper actuators		GSD..	4603	2-Position & TPI slow
Damper actuators		GQD..	4604	2-Position & TPI slow
Rotary damper actuators		GXD..	4622	2-Position & TPI slow
Cable temperature sensor		QAH11.1	1840	N/A
Room temperature sensors		QAA32 ..	1747	N/A

*) The documents can be downloaded from <http://siemens.com/bt/download>.

Mechanical design

The room thermostat consists of 3 parts:

- Plastic housing which accommodates the electronics, the operating elements and the room temperature sensor
- Mounting plate with screw terminals
- Table stand

The housing engages in the mounting plate and is secured with a screw. The optional table stand snaps onto the rear of the mounting plate.

The RCR100RF receiver consists of 2 parts:

- Plastic housing which accommodates the electronics
- Mounting plate with screw terminals

Operation and settings

RDE100.1RF

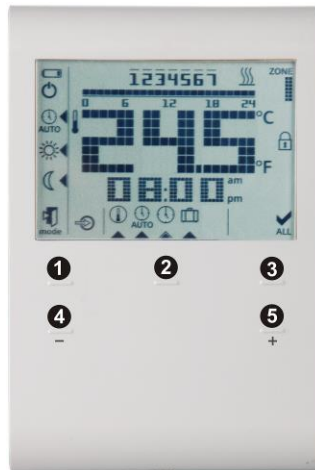

- 1) Touchkey for operating mode
- 2) Settings
- 3) Ok
- 4) Touchkey for decreasing a value
- 5) Touchkey for increasing a value

RCR100RF



- 1) LED for indication of operating state
- 2) LEARN button (or override)

Display

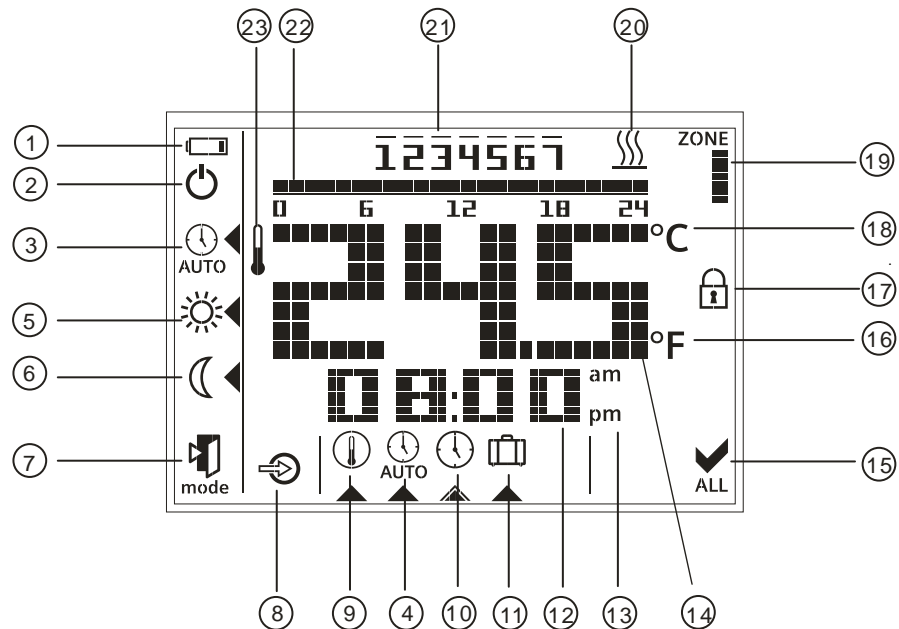

#	Symbol	Description	#	Symbol	Description
1		Indicating that batteries need to be replaced	13	am pm	Morning: 12-hour format Afternoon: 12-hour format
2		Protection mode (Protection mode symbol can be enabled via parameter settings)	14		Display of room temperature, setpoint, etc.
3		Auto Timer mode	15		Confirmation
4		View and set time switches	16	°F	Room temperature in degrees Fahrenheit
5		Comfort mode	17		Touchkey lock activated
6		Economy mode	18	°C	Room temperature in degrees Celsius
7		Escape	19	ZONE 	Display of zone (default is 1)
8		External input enabled	20		Heating On
9		Adjustment of setpoint	21		Weekday 1 = Monday Weekday 7 = Sunday
10		Setting of weekday and time of day	22		Timer bar
11		Setting of Holiday mode	23		Current room temperature
12		Display of time of day			

Mounting and installation notes

Do not mount the thermostat in niches or bookshelves, not behind curtains, not above or near heat sources, and not exposed to direct solar radiation. Mount it about 1.5 m above the floor.

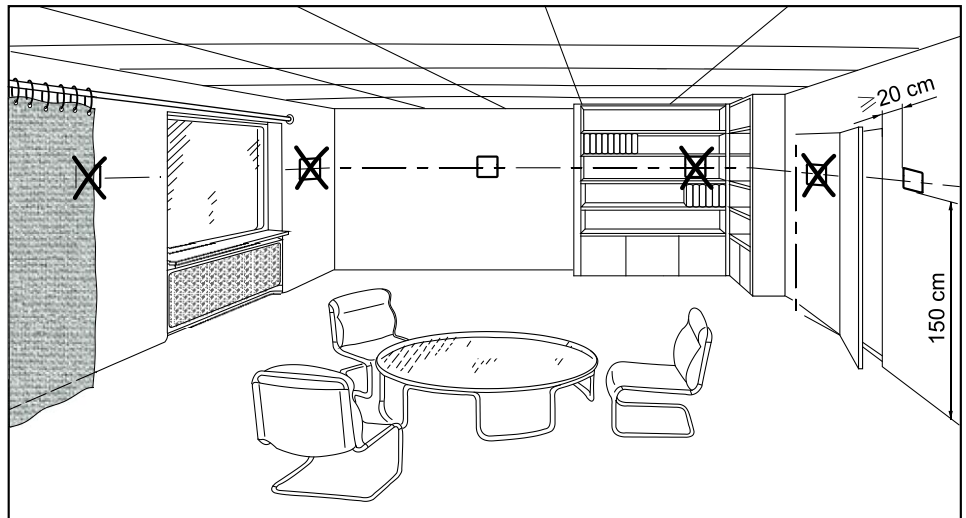

Mounting



- Mount the room thermostat in a clean and dry location without direct air flow from heating/cooling equipment, and not exposed to drip or splash water
- Install the receiver close to the controlled unit if possible
- Choose the location to ensure largely interference-free reception. When mounting the receiver, observe the following:
 - Do not mount in a control panel
 - Do not mount on metallic surfaces
 - Do not mount near electrical cables and equipment such as PCs, TVs, microwaves, etc.
 - Do not mount near larger metallic structures or constructional elements with fine metal meshes such as special glass or special concrete

Wiring

See Mounting Instructions CB1M1439xx enclosed with the thermostat.



- Ensure that wiring, protection and earthing comply with local regulations
- Correctly size the cables to the thermostat and the valve actuators
- Use only valve actuators rated for AC 24... 230 V
- If the thermostat cannot accommodate all cables, power must be fed to the system via an external terminal block



Warning!

No internal line protection for supply lines to external consumers.

Risk of fire and injury due to short-circuits!



- Adapt the line diameters as per local regulations to the rated value of the installed overcurrent protection device.



- The AC 230 V mains supply line must have a circuit breaker with a rated current of no more than 10 A



- Disconnect from power supply before removing the unit from its mounting plate
- External inputs X1, \perp may carry mains potential. Sensor cables or window contact must be carefully installed before applying power to the thermostat



- Make sure the receiver is not connected to power during wiring

Commissioning notes

Commissioning	<p>After power is applied, the thermostat carries out a reset during which all LCD segments flash, indicating that the reset is correctly made. After the reset, the thermostat is ready for commissioning by qualified HVAC personnel.</p> <p>The control parameters of the thermostat can be set to ensure optimum performance of the entire system (refer to Operating Instructions CB1B1425en, section "Do you want to change parameters?").</p>
Sensor calibration	<p>If the temperature shown on the display does not agree with the room temperature effectively measured, the temperature sensor can be recalibrated. For that purpose, adjust parameter P04.</p>
Setpoint lock	<p>We recommend to review the setpoint lock (for public spaces) using parameters P06 and P08 and change them as needed. If the Economy setpoint is locked then the Comfort temperature setpoint can not be set lower than the locked Economy setpoint.</p>
Touchpad scanning rate	<p>Since the thermostat uses touch technology and to minimize battery power consumption, parameter P21 (adjustable from 0.25 to 1.5 seconds) is implemented for the user to adjust.</p> <p>This means that when, for a certain time, the user does not touch the touchpad, the unit operates in power saving mode and the touchpad is running at a scanning rate of 1 second.</p> <p>(From the calculation – assuming 4 operations per day on the thermostat, the estimated 1-second scanning rate results in a battery life of 1 year. If the user increases the scanning rate, the batteries' life is extended.</p>
X1 external input	<p>Different parameter setting of X1 external input is described below:</p> <p>Parameter P14=0 (No Input) is a default setting, which provides no external input function.</p> <p>Digital input</p> <p>An external contact can switch the thermostat from any operating mode to Economy.</p> <p>Typical applications: Window contact Key card application</p> <p>Set parameter P14 = 2 (X1 External input = Digital Input) and adapt parameter P17 (Window contact = Normally Open / Closed) accordingly.</p> <p>External sensor (used for controlling)</p> <p>The measured external sensor temperature is displayed and used for calculating heating demand instead of temperature detected by thermostat built-in internal sensor. In case of problems with the external sensor, the thermostat uses the internal sensor instead.</p> <p>Typical applications: External room temperature sensor Floor heating temperature control bath room</p>

Setting parameter P14 = 1 (X1 External input = External Sensor) and parameter P15 = 0 (Temperature limitation = Off)

Notes for floor heating temperature control:

- External safety thermostat is needed to prevent overheating of certain floor heating systems!
- Use of "Comfort setpoint lock" function (Parameter P06) is recommended.

External sensor for Floor heating application with temperature limitation

Refer to Floor Heating application section above when setting parameter P14 = 1 (X1 External input = External Sensor) and parameter P15 = 1 (Temperature limitation = On). Parameter P16 now allows to limit the maximum temperature.

Change of batteries

If the battery symbol  appears, the batteries are almost exhausted and should be replaced. Use alkaline batteries type AAA.

LED indication on RCR100RF

For the pairing process between transmitter and receiver, refer to Operating Instructions CB1B1425en, section "Do you want to pair transmitter and receiver?". The table below describes the behavior of the RCR100RF:

State of receiver	State of LED
Power up (or reset)	The red and green LEDs flash alternately for 5 seconds and then change to constantly red. Note: If the receiver was programmed before, it will immediately change to constantly red.
Learning mode Successful learning mode	The red and green LEDs flash alternately. If learning was successful, the green LED will flash for 10 minutes.
Signal ok and output status change	The green LED is lit. If the output state changes, the green LED flashes for 3 seconds and then changes back to constantly green.
Fails to receive wireless data	If the RCR100RF fails to receive wireless data, the red LED will start to flash after 125 minutes. If the RCR100RF signal is recovered, it will resume the previous LED state.

Override via the RCR100RF

The receiver provides an override function (boiler test, emergency operation). It allows the installer to override the relay to be permanently energized, regardless of the wireless data received.

To activate the override function, press and hold the  button for at least 10 seconds and release. The LED is constantly green and off once every 5 seconds, indicating that the override function is enabled.

To disable the override function, press the  button once.

Operating notes

The RDE100.1RF provides Comfort, Economy, Auto Timer and Protection mode. The difference between Comfort and Economy mode is only the room temperature setpoint. The changeover between Comfort, Economy and Protection mode is made either automatically by the time switch or by pressing the touchkey for the operating mode.

Comfort mode

When Comfort mode is activated, symbol  appears on the display. The setpoint (20 °C) can be readjusted by pressing touchkeys + and –.

Economy mode

When Economy mode is activated, symbol  appears on the display. The setpoint (16 °C) can be readjusted by pressing touchkeys + and –.

With the RDE100.1RF, the user can connect a window contact to input X1, . Depending on whether the window contact is configured for NO or NC (P14 = 2, P17 = 0 or 1), a change in this state will automatically switch the thermostat from any operating mode to Economy. This feature is suited for public spaces. The factory setting is Off (disabled).

Protection mode

If the temperature falls below 5 °C, the unit automatically activates the heating output. Symbol  appears only if the icon is enabled via parameter settings.

Auto Timer

When Auto Timer mode is enabled, the changeover between the operating modes (Comfort and Economy) takes place automatically. There are 3 options for time switch settings: Individual days, 7 days, or days 5-2. You can select Comfort or Economy mode at 15-minute intervals of the day. The 0:00 to 24:00 hour time bar allows you to set the operating mode throughout the selected day(s).

Default value	Day/s	Comfort mode	Economy mode
	Mo (1) – Fr (5)	6:00 – 8:00 hr 17:00 – 22:00 hr	22:00 – 6:00 hr 8:00 – 17:00 hr
	Sa (6) – Su (7)	7:00 – 22:00 hr	22:00 – 7:00 hr

Refer to Operating Instructions CB1B1425, section "Do you want to enter your own time switch?".

Holiday mode

When Holiday mode is activated, symbol  appears on the display. The setpoint (12 °C) and the number of days a user is absent can be adjusted by pressing touchkeys + and –.

Parameters

Changing the parameters by the following steps:

- Press + and – simultaneously for 5 seconds
- Release them and parameter "P01" is displayed on the bottom segment
- Press + or – to scroll to the parameter that needs to be adjusted
- Press **ok** to select this parameter
- Press + or – to adjust the value
- Press **ok** to confirm the adjusted value
- Press mode to exit the parameters without saving or wait for the program to exit automatically

Parameter list

Parameter no.	Description	Setting range (default)
P01	Time format	1 = 24:00 hours (default) 2 = 12:00 AM/PM
P02	Selection of °C or °F	1 = °C (default) 2 = °F

P03	Standard temperature display	1 = room temperature (default) 2 = setpoint
P04	Temperature sensor calibration	-3...3 °C Step 0.5 °C (-6...6 °F, step 1 °F) Default: 0 °C
P06	Comfort setpoint lock	0 = OFF (default) 1 = ON → locked according to setting in permanent temperature setpoint
P08	Economy setpoint lock	0 = OFF (default) 1 = ON → locked according to setting in permanent temperature setpoint
P09	Buzzer	0 = OFF 1 = ON (default)
P10	Show frost protection icon	0 = OFF (default) 1 = ON
P11	Time switch type for auto timer	0 = Individual Days (default) 1 = All 7 days 2 = 5/2 days
P12	Periodic pump run	0 = OFF (default) 1 = ON
P14	X1 External input	0 = No input (default) 1 = External sensor 2 = Digital Input
P15	Temperature limitation	0 = OFF (default) ← 1 = ON ←
P16	Max limitation temperature for underfloor heating	25...60 °C, step 1 °C or 77...140 °F, step 1 °F ← Default: 30 °C
P17	Window contact	0 = Normally Open Contact (default) 1 = Normally Closed Contact
P19	Sequence number of room unit	0 = no display of zone (RF off) 1 = zone number 1 (for standard RF) (default) 6 = zone number 6
P20	RF learn	0 = OFF (default) 1 = ON
P21	Button scanning rate for the capacitive buttons Note: a shorter scanning rate means shorter battery life.	0.2 = 0.25 s 0.5 = 0.5 s 1.0 = 1.0 s (default) 1.5 = 1.5 s
P22	Reload factory settings	0 = OFF (default) 1 = reload
P23	Software version information	No adjustment possible

P78	Control behavior	0 = On/Off, 1.0 K 1 = On/Off, 0.3 K 2 = TPI fast 3 = TPI medium 4 = TPI slow (default)
P89	Forward shift on max	0, 0.5,...24 h Default: 0 h
P90	Early shutdown max	0, 0.5,...6 h Default: 0 h

Maintenance note

Thermostat and receiver are maintenance-free.

Disposal



This symbol or any other national label indicate that the product, its packaging, and, where applicable, any batteries may not be disposed of as domestic waste. Delete all personal data and dispose of the item(s) at separate collection and recycling facilities in accordance with local and national legislation. For additional details, refer to www.siemens.com/bt/disposal.

	<p>⚠ WARNING</p> <p>Risk of explosion due to fire or short-circuit, even if the batteries are empty</p> <p>Risk of injuries from by flying parts</p> <ul style="list-style-type: none"> Do not allow the batteries to come into contact with water. Do not charge the batteries. Do not damage or destroy the batteries. Do not heat the batteries to more than 85 °C.
--	--

	<p>⚠ WARNING</p> <p>Electrolyte leakage</p> <p>Chemical burns</p> <ul style="list-style-type: none"> Only grasp damaged batteries using suitable protective gloves. If electrolyte comes into contact with eyes, immediately rinse eyes with plenty of water. Consult a doctor.
--	---

Observe the following:

- Only replace batteries with batteries of the same type and from the same manufacturer.
- Observe the polarities (+/-).
- The batteries must be new and free from damage.
- Do not mixed new batteries with used batteries.
- Store, transport, and dispose of the batteries in accordance with local regulations, guidelines, and laws. Also observe information from the battery manufacturer.

Technical data of RDE100.1RF

 Power supply	Operating voltage	DC 3 V (2 x 1.5 V alkaline batteries AAA)
	RDE100.1RF	
	For battery life (RDE100.1RF), see below (alkaline batteries type AAA). Battery life calculation is based on the touchpad scanning rate during idle time (assuming a user presses 4 touchkeys per day with default TPI Slow control):	
	Scanning rate 0.25 s	1.1 year battery life
	Scanning rate 0.5 s	1.1 year battery life
	Scanning rate 1 s (default)	1.3 year battery life
External sensor	Scanning rate 1.5 s	1.3 year battery life
	External sensor (RDE100.1RF)	
	'X1' - '⏴' (reference)	QAH11.1 (NTC 3K) / QAA32
	Temperature range	0...60 °C
Function data	Cable length	Max. 80 m
	or	
	Digital On/Off	
	'X1' - '⏴' (reference)	On/Off switch
	Comfort mode	20 °C (5...35 °C)
	Economy mode	16 °C (5...35 °C)
Environmental conditions	Holiday mode	12 °C (5...35 °C) (standalone)
	Built-in room temperature sensor	
	Setpoint setting range	5...35 °C (Comfort/Economy mode)
	Accuracy at 25 °C	< ±0.5 K
	Temperature calibration range	±3.0 K
	Resolution of settings and displays	
	Setpoints	0.5 °C
	Temperature value displays	0.5 °C
	Operation	As per IEC 60721-3-3
	Climatic conditions	Class 3K5
Temperature	0...50 °C	
Humidity	<95% r.h.	
Standards and directives	Transport	As per IEC 60721-3-2
	Climatic conditions	Class 2K3
	Temperature	-25...65 °C
	Humidity	<95% r.h.
	Mechanical conditions	Class 2M2
	Storage	As per IEC 60721-3-1
	Climatic conditions	Class 1K3
	Temperature	-25...65 °C
	Humidity	<95% r.h.
	EU Conformity (CE)	CE1T1420xx ^{*)}
RCM conformity	CE1T1420en_C1 ^{*)}	
Environmental compatibility	Safety class	II as per EN 60730-1, EN 60730-2-9
	Pollution class	II as per EN 60730-1
	Degree of protection of housing	IP30 as per EN 60529
	The product environmental declaration CE1E1420xx ^{*)} contains data on environmentally compatible product design and assessments (RoHS compliance, materials composition, packaging, environmental benefit, disposal).	



Meets the requirements for eu.bac certification as per EN 15500-1
 See product list at: <http://www.eubacert.eu/licences-by-criteria.asp>
 RDE100.1RF (license 221178)

Control accuracy [K]
0.4

Water Heating System
(thermal actuator, On/Off)

Water Floor Heating Systems
(thermal actuator, On/Off) 0.3

Eco design and labelling directives

Based on EU Regulation 813/2013 (Eco design directive) and 811/2013 (Labelling directive) concerning space heaters, combination heaters, the following classes apply:

- Application with On/Off operation Class I value 1% of a heater
- TPI (PWM) room thermostat, for Class IV value 2% use with On/Off output heater

General

Connection terminals for	Solid wires or prepared stranded wires 2 x 1.5 mm ² or 1 x 2.5 mm ² (Min. 0.5 mm ²)
Weight	0.179 kg
Color of housing front	RAL9003

*) The documents can be downloaded from <http://siemens.com/bt/download>.

Technical data of RCR100RF



Power supply

Operating voltage	AC 230 V +10/-15%
Power	<10 VA
Frequency	48...63 Hz
Switching capacity of relays	



Switching outputs (Q11, Q12, Q14)

Voltage	AC 24...230 V
Current	8 (2) A
Switching voltage	Max. AC 230 V Min. AC 24 V
Switching current	Max. 8 A res., 2 A ind.
At AC 230 V	Min. 200 mA



No internal fuse.

External preliminary protection with max. C 10 A circuit breaker in the supply lines required under all circumstances.

External protection for incoming cable

Circuit breaker	Max. 10 A
Circuit breaker tripping characteristic	Type B, C or D to EN 60898 and EN 60947
Contact life at AC 230 V	Guide value:
At 8 A res.	1 x 10 ⁵ cycles

Insulating strength

Between relay contacts and coil	AC 5,000 V
Between relay contacts (same pole)	AC 1,000 V

Electrical connections

Connection terminals	Screw terminals
For solid wires	2 x 1.5 mm ²
For stranded wires	1 x 2.5 mm ² (Min. 0.5 mm ²)

Environmental conditions

Operation	As per IEC 60721-3-3
Climatic conditions	Class 3K5
Temperature	0...50 °C
Humidity	<95% r.h.

Transport	As per IEC 60721-3-2
Climatic conditions	Class 2K3
Temperature	-25...65 °C
Humidity	<95% r.h.
Mechanical conditions	Class 2M2
Storage	As per IEC 60721-3-1
Climatic conditions	Class 1K3
Temperature	-25...65 °C
Humidity	<95% r.h.
Standards and directives	
EU Conformity (CE)	CB1T1420xx *)
RCM conformity	CE1T1420en_C1*)
Safety class	II as per EN 60730-1, EN 60730-2-9
Pollution class	II as per EN 60730-1
Degree of protection of housing	IP30 as per EN 60529

Environmental compatibility

The product environmental declaration CE1E1420xx *) contains data on environmentally compatible product design and assessments (RoHS compliance, materials composition, packaging, environmental benefit, disposal).

General

Weight	0.152 kg
Color of housing front	RAL9003

*) The documents can be downloaded from <http://siemens.com/bt/download>.

Connection diagrams

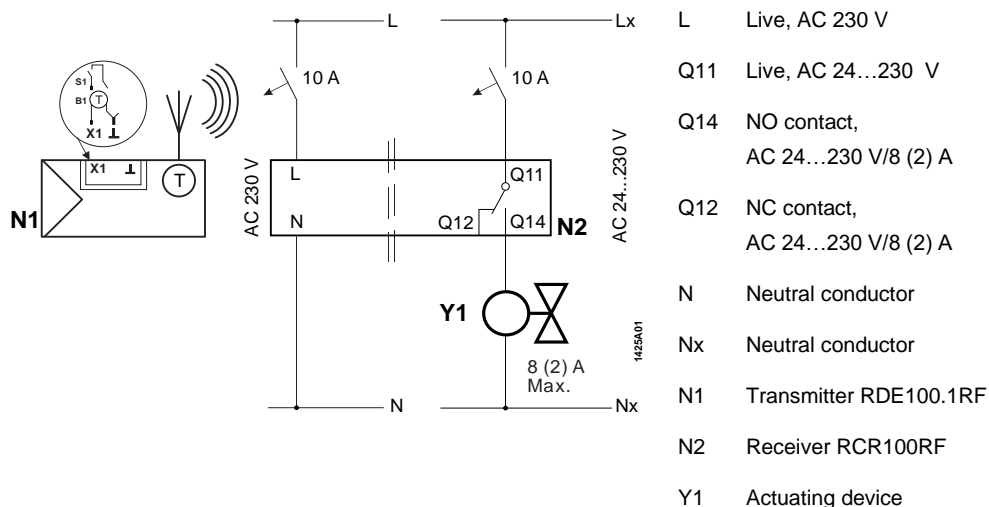

⚠ L – N AC 230 V / Lx – Nx AC 24...230 V

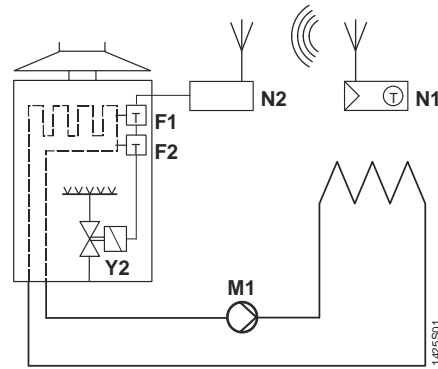

Room thermostat with direct control of a gas-fired wall-hung boiler

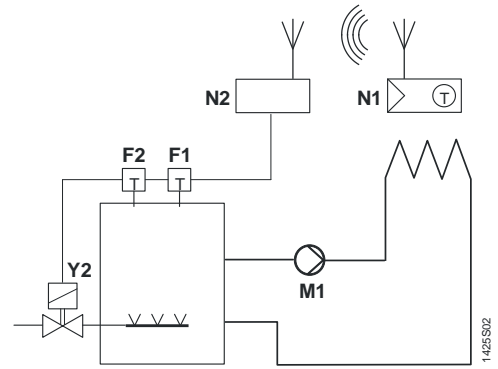

Room thermostat with direct control of a gas-fired floor-standing boiler

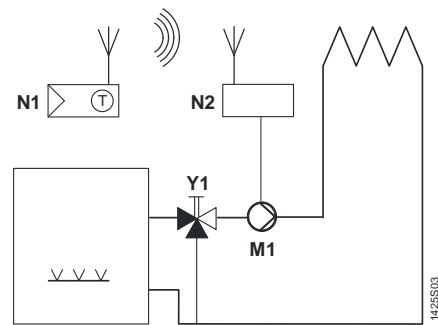

Room thermostat with direct control of a heating circuit pump (precontrol by manual mixing valve)

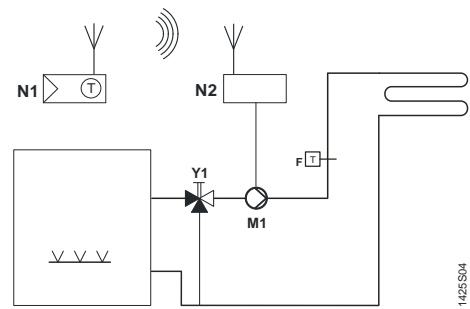

Room thermostat with direct control of a hydronic floor heating system

- F1 Thermal reset limit thermostat
- F2 Safety limit thermostat
- M1 Circulating pump
- N1 RDE100.1RF room thermostat
- Y1 3-port valve with manual adjustment
- Y2 Magnetic valve

Dimensions

Dimensions in mm

Room thermostat RDE100.1RF

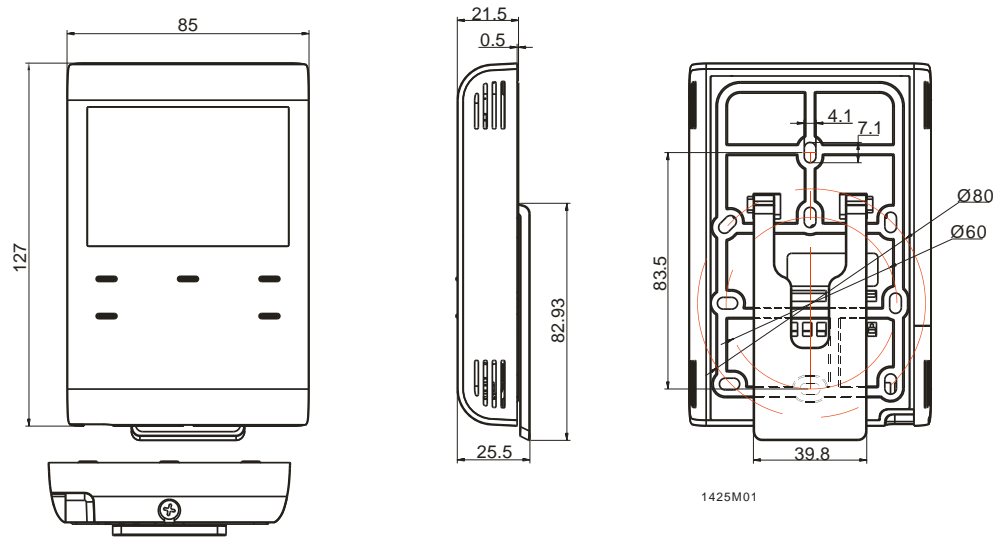

Receiver RCR100RF

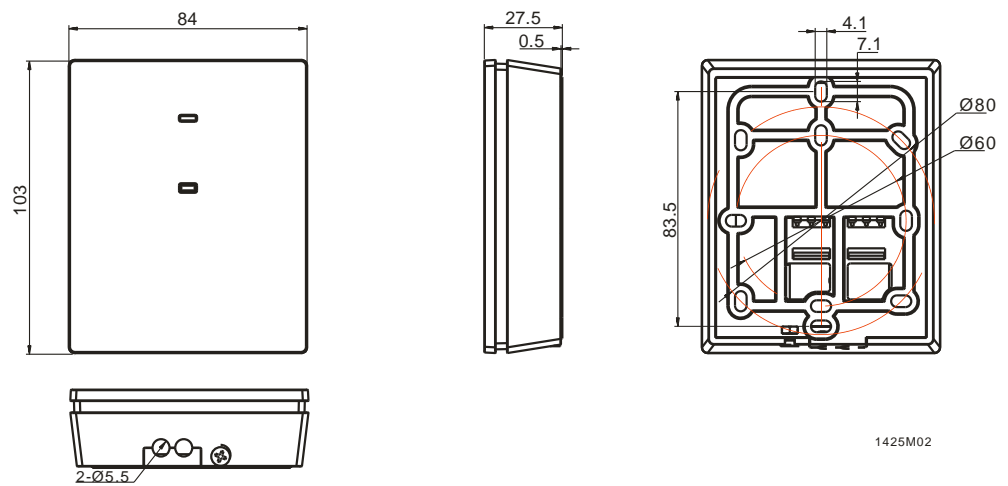

Issued by
Siemens Switzerland Ltd
Smart Infrastructure
Global Headquarters
Theilerstrasse 1a
CH-6300 Zug
Tel. +41 58 724 2424
www.siemens.com/buildingtechnologies

© Siemens 2017-2023
Technical specifications and availability subject to change without notice.